



WOLF
[POWER SYSTEMS]



DECENTRALISED ENERGY SUPPLY

YOUR SYSTEM PROVIDER FOR EFFICIENT, FUTURE-ORIENTED CHP SOLUTIONS



Sustainability and environmental awareness are our driving forces. With our comprehensive knowledge of decentralised energy production and combined heat and power generation, we are actively involved in the energy transition. Our quality standards and precise project execution create customer values.



MORE THAN
2,300
INSTALLED
SYSTEMS

PRODUCTION
CAPACITY
40 MW
INSTALLED ELECTRICAL
OUTPUT IN TURNKEY
PLANTS PER YEAR

POWER FOR MODERN ENERGY GENERATION

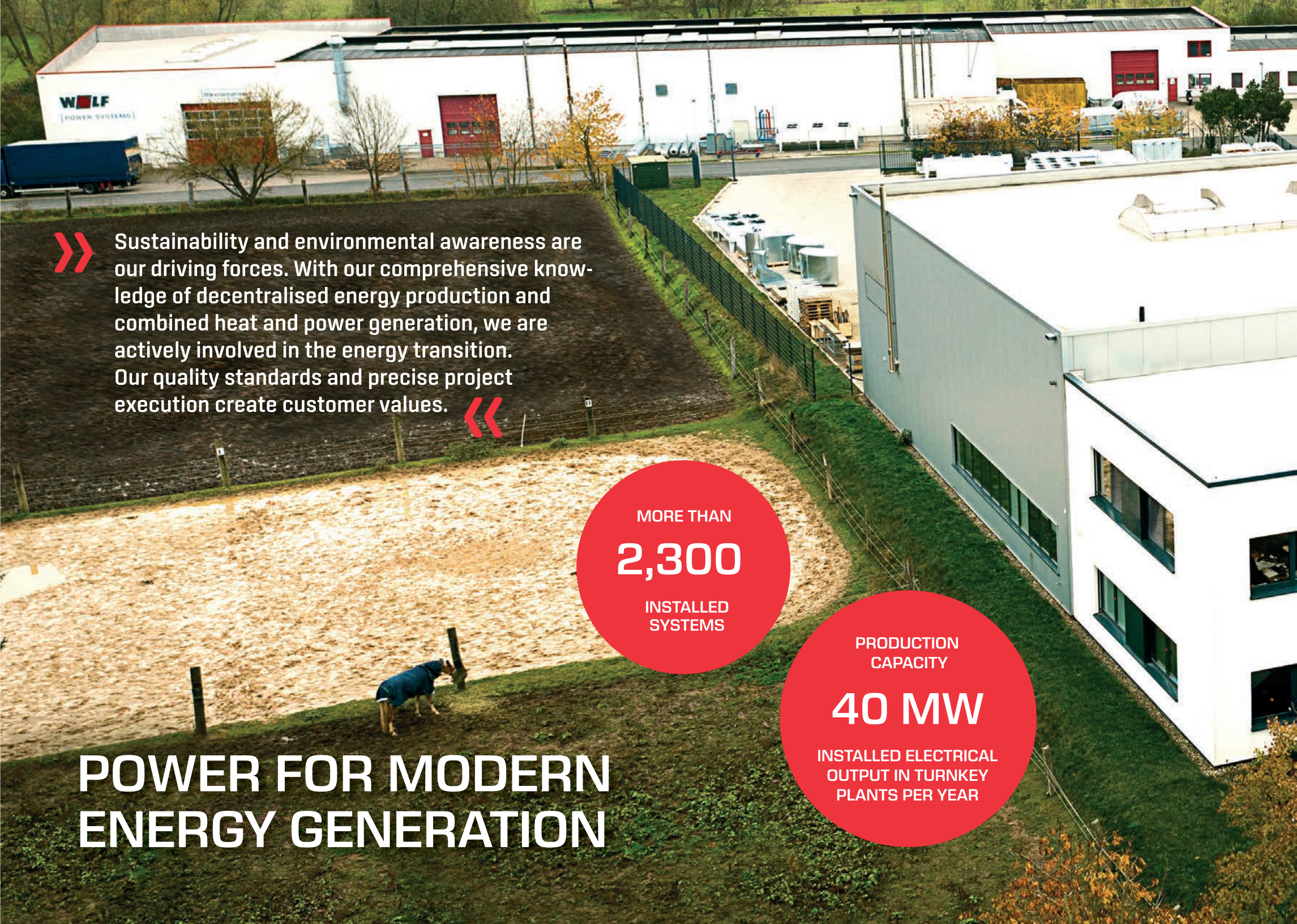



WOLF
[POWER SYSTEMS]

A TOTAL CAPACITY
OF MORE THAN

560 MW

OUTPUT IN ALL
INSTALLED PLANTS

ELECTRICAL OUTPUT

**35 kW TO
2000 kW**

POWER RANGE FOR
INDIVIDUAL
COMPONENTS

WOLF
[POWER SYSTEMS]



Gorleben



Wolfhagen



Mainburg





[POWER SYSTEMS]

EXPERTISE FROM OVER 35 YEARS EXPERIENCE

THE SYSTEM PROVIDER FOR COMBINED HEAT AND POWER PLANTS

FOCUSED ON EFFICIENCY AND DURABILITY

WOLF Power Systems GmbH has more than 35 years of CHP experience from more than 2,300 projects worldwide. We can offer solutions for energy recovery from natural gas, biogas as well as sewage and liquefied natural gas "from a single source", which we have developed for and together with our customers.

We attach particular importance to the optimal design of the system, tailored to your needs and local conditions, taking into account the surrounding electricity and heating networks. This is the only way to make full use of the technical potential of the individual CHP components and achieve high system efficiency. Excellent efficiency leads to a faster payback for your plant.

That is why our products and services, our employees and our system solutions are above all one thing: Fully geared to you.

We create a complete solution for your very special system world. Thanks to our many years of experience in plant engineering and high flexibility, we can develop solutions for almost every application requirement. Our employees accompany you from the initial feasibility studies, planning and project planning, through construction and commissioning, to the maintenance and service of your CHP.

At our two locations in Gorleben and Wolfhagen, as well as with our decentralised engineering, sales and service team, we are always available to respond to all questions relating to combined heat and power generation with innovative, intelligent and reliable solutions.

OUR PHILOSOPHY:

HIGHEST QUALITY
MADE IN GERMANY

From combined heat and power plants to heating, ventilation and air conditioning technology, you can get future-oriented complete solutions from the WOLF world "Made in Germany."

All CHP components are produced exclusively in Germany. In this way, we guarantee a particularly high quality and durability of our products.

In addition, all our systems undergo a performance test before they leave our factories. This is because we want all our products to function perfectly and reliably to the highest possible standard.

This also applies to our service personnel: all employees are trained in Germany and receive state-of-the-art technical qualifications directly from the engine manufacturer.



SECURITY THROUGH PARTNERSHIP GLOBAL PLAYER IN ENERGY

GROUP MEMBERSHIP WE ARE PART OF THE WOLF GROUP

As one of the leading system providers of heating and air conditioning systems, WOLF can be found from the Red City Hall in Berlin to the Kremlin in Moscow. At home in Mainburg, with 14 sales offices in Germany, 8 subsidiaries in Europe and one subsidiary in China as well as more than 60 other sales partners worldwide, we are everywhere, operating globally for you.

WOLF supports design engineers, installers and end customers in the integrated planning and coordination of heating and air conditioning components for the areas of heating, solar, air conditioning and ventilation. In short: WOLF ensures an optimal indoor climate - for detached houses and apartment blocks right through to office buildings and industrial facilities.

Since 2016, WOLF Power Systems has been WOLF's business unit for combined heat and power plants and power systems. The merger makes it easier to exploit synergies with existing suppliers and partners in their individual fields. With this background, we offer our customers a reliable partner with bundled expertise in all matters relating to energy.

THE 3 BUSINESS UNITS OF WOLF – THE SYSTEM PROVIDER

The merger of Dreyer and Bosse Kraftwerke GmbH and Kuntschar and Schlüter GmbH created one of the leading companies for individual CHP solutions and CHP service. Each brand retained its area of expertise.

Dreyer and Bosse are regarded as specialists in biogas CHP solutions and are also pioneers of new technologies, such as gas cleaning with a two-stage activated carbon filter and the oil management system. Kuntschar and Schlüter are pioneers of CHP solutions in the sewage gas sector.

Each area continues to operate independently and is highly specialised, yet the units combine flexibly in the interests of the customer in order to offer the most suitable system solution and to optimally exploit the existing potential. The customer also has additional security when he can realise complex projects with a large partner such as WOLF.

Since 2017, as a result of the merger, our products have been completely designed at our Wolfhagen site and built with our own technology, whilst a training centre for operators, service partners and employees has been built at the Gorleben site. In addition, belonging to the WOLF Group offers us perfect opportunities to integrate market and research developments into our thinking and action.

FOR YOU, THIS MEANS IN CONCRETE TERMS:

- Security through the expertise of the market leader
- Upgrade possibilities by using the entire value chain:
 - Biogas production
 - Self-sufficiency (heat/electricity generation)
 - Biogas cleaning and feeding into natural gas networks
- Profit maximization through individually tailored component configuration
- Cost efficiency from high reliability and dedicated service



PREMIUM MANUFACTURER AND TECHNOLOGY LEADER

SEAMLESS INTEGRATION OF INDIVIDUAL EXPERTISE AREAS



WOLF is the only system provider for heating, air conditioning, ventilation and CHP in Europe.

How our individual areas of expertise can be effectively interlinked is shown by the configuration of this large-scale project in the industrial and commercial sector.

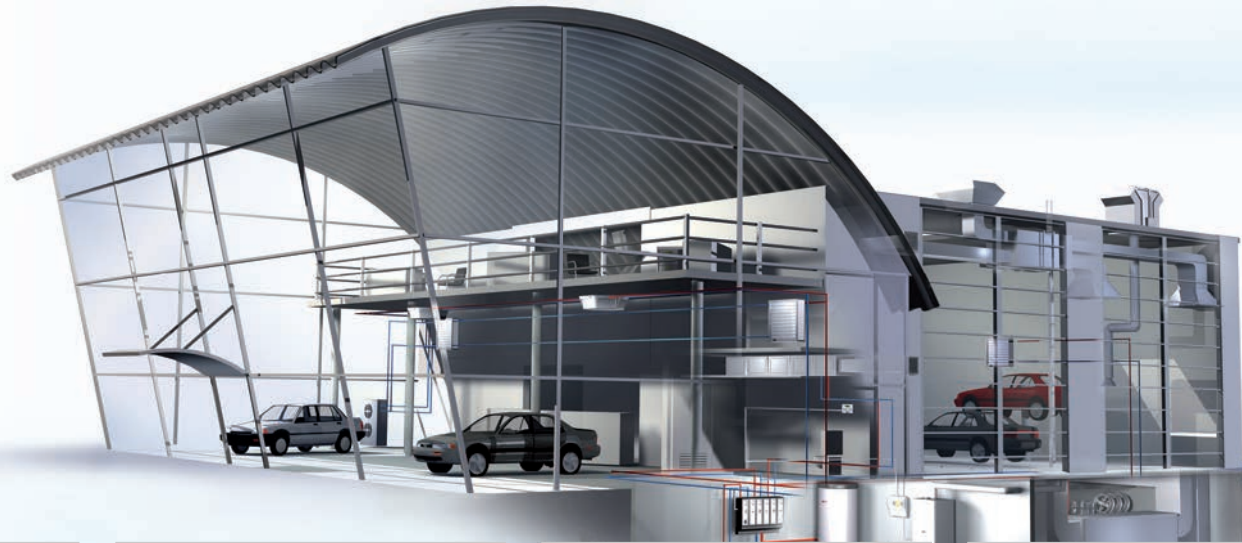

COOLING SYSTEMS

- Heat recovery
- Integrated refrigeration
- Hygiene
- Dehumidification
- Flat units



VENTILATION SYSTEMS

- Comfort ventilation units
 - Compact units
 - Flat units
 - Large units
- Air heater
- Roof ventilators
- Warm air generators
- Door air curtains



HEATING SYSTEMS

- Gas condensing medium boiler
- Large oil and gas boilers



POWER SYSTEMS (CHP)

- Electrical output
35 - 2000 kW
- Thermal output
34 - 1970 kW

The logo for WOLF, featuring the word "WOLF" in a bold, white, sans-serif font with a red circle above the letter "O".

WOLF

[POWER SYSTEMS]

NATURAL
GAS

LIQUID
GAS

SYSTEM SOLUTIONS
FOR

5

GAS TYPES

BIOGAS

SEWAGE
GAS

P2G
HYDRO-
GEN

MARKET LEADER IN
SEWAGE GAS PLANTS AND

ONLY

SUPPLIER WITH PRODUCTS
COMBINING CHP AND
E-MOBILITY



The focus of our work is always on the customer and his power plant. We are looking at what type of use is appropriate for you, to achieve optimal performance and efficiency results, whilst minimizing maintenance requirements.



**35
YEARS**
EXPERIENCE

**PERFECT PRODUCTS
FOR EVERY NEED**

P2G

Power-to-Gas

- Gas from surplus renewable electricity replaces fossil gas

P2G

GREEN GAS AND HYDROGEN REPLACE FOSSIL FUEL SOURCES

NATURAL GAS COMBINED HEAT AND POWER PLANT

50 kW to 2,000 kW

- Supply reliability
- Independence from electricity, gas and heating oil prices
- For energy-intensive areas
- profitability



BIOGAS COMBINED HEAT AND POWER PLANT

50 kW to 2,000 kW

- Use of renewable resources
- Exploitation of organic resources
- Gas cleaning during operation

SEWAGE GAS COMBINED HEAT AND POWER PLANT

30 kW to 2,000 kW

- Market leader for sewage gas CHP
- For civic services
- For sewage and wastewater treatment plants

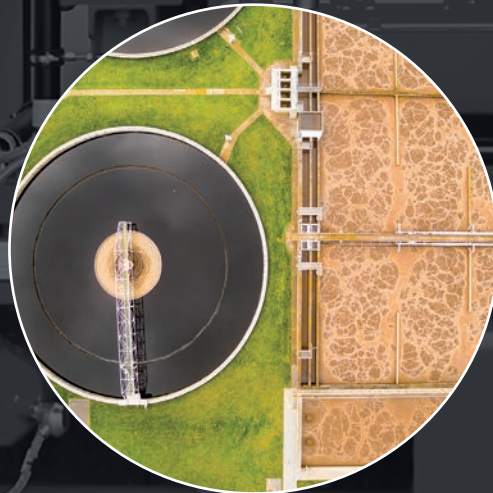

LIQUEFIED GAS COMBINED HEAT AND POWER PLANT

50 kW to 105 kW

- Independent energy supply
- Suitable for places without gas supply, e.g. islands or mountains

SPECIALIST FOR GAS USE

INTELLIGENT SOLUTIONS FOR ALL GAS AND POWER AREAS

LOOKING AHEAD

At WOLF PS we think, develop and act in a future-oriented manner. That is why we already have a solution in place to respond to the inevitable depletion of conventional fossil energy resources at some point in time and to respond to changes in mobility.





In the future, the current natural gas network can be ideally used for the supply of green gas, which is generated from surplus renewable electricity (power-to-gas).

For example, green hydrogen or synthetic natural gas can be used for this purpose. Biogas is also a particularly versatile, renewable and CO₂ neutral energy source.

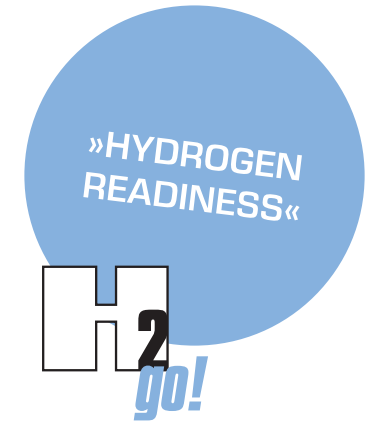
HYDROGEN READINESS

Our plants are compatible for mixing hydrogen into the natural gas grid according to DVGW worksheets G260 and G262 with up to 10 percent by volume. These admixture rates do not lead to performance and efficiency reductions. A specific examination of the limiting conditions and gas qualities is required.



 [POWER SYSTEMS]				
Input	P2G H ₂ NATURAL GAS CHP SOLUTIONS	LIQUEFIED GAS CHP SOLUTIONS	SEWAGE GAS CHP SOLUTIONS	BIOGAS CHP SOLUTIONS
Output	50 kW to 2 MW	50 kW to 105 kW	30 kW to 2 MW	50 kW to 2 MW
Brand	 [POWER SYSTEMS]	KUNTSCHAR +SCHLÜTER  [WOLF POWER SYSTEMS]	DREYER +BOSSE  [WOLF POWER SYSTEMS]	

HYDROGEN CHP (H₂ CHP) AND POWER-TO-GAS (P2G)

Hydrogen combined heat and power plant (H₂ CHP) for electricity recovery from renewably sourced hydrogen. The special H₂ technology makes it possible to operate with pure hydrogen without adding fossil fuel. This will enable the realisation of a purely hydrogen-based and CO₂-free storage chain for renewable electricity.

The electrical energy generated from renewable sources, e.g. from wind or solar power, is used for the conversion of water into hydrogen. The technical implementation is carried out by electrolysis in an electrolyser. The hydrogen is kept in pressure tanks and converted back into heat and electricity, as required, in the H₂ CHP. With the system, power surpluses and shortages can be levelled out, and the local power supply secured. Self-sufficient island operating solutions are also possible.

FLEXIBLE IN ANY INITIAL SITUATION

SPECIAL CIRCUMSTANCES REQUIRE ADAPTED CHP CONCEPTS

APPLICATION AREAS

CHPs are used in almost all sectors to improve energy balance, especially where large heat and electricity requirements are to be met:

- Residential properties with many residential units
- Supermarkets, department stores and shopping centres and in goods distribution centres
- Banks and insurance companies
- Clinics and care facilities
- Administration and educational institutions
- Sports venues such as indoor swimming pools and stadiums
- Hotels and restaurants
- Industrial and craft enterprises
- Farms with and without biomass usage sewage treatment plants
- And much more

A combined heat and power plant solution that is perfectly adapted to your individual requirements must not only be seamlessly integrated into your industrial or commercial property, but also optimally tuned to the electricity market. This is the only way to ensure the economic success of your plant.

SPECIAL SOLUTIONS

As a solution provider, our expertise does not end with CHP, but also includes the equipping of complete heating systems, as well as the connection and integration of special solutions that make a valuable contribution to environmental protection.



Special solutions include:

- **Cooling solutions**
in combination with adsorption or absorption-refrigeration machines for cooling or air conditioning
- **Production of process heat or steam/water vapour**
- **Solutions for drying wood chips, cereals, etc.**
Increase of the calorific value and prevention of substance loss due to biological degradation processes. Avoidance of spontaneous ignition through chemical and biological processes.
Additional production of electricity and heat, and more drying air from heat exchangers.
Puts an end to corrosion or moisture accumulations.
- **Waste heat electricity generation/ORC**
with increased efficiency and additional electricity. Here, a combination of different engines and sizes is possible.
- **Solutions for CO₂ fertilization**
Optimization of growth and yield. By cleaning and redirecting the engine exhaust gases, the CO₂ concentration in the greenhouse is increased, thus, stimulating plant growth.
- **Solutions for seawater treatment**
with the help of a single-stage distiller. Low maintenance, fully automatic, and built-in salinity control producing up to 100 tons of water per day. Useful where water supply is limited and in arid areas.
- **Island operation and emergency power solutions**
- **And much more**



Example grain drying



Example process heat



Example CO₂ fertilization



Example wood chip drying



Example seawater treatment



CO₂ EMISSION
REDUCTION OF UP TO

60 %

COMPARED TO CURRENT
ELECTRICITY MIX

EFFICIENCY LEVELS

≥ 90 %



Intelligent, energy-efficient and with virtually no losses:
Combined heat and power generation is one of the most
efficient and economical options for energy conversion
and energy supply.



**PROFITABLE, DECENTRALISED
AND INDEPENDENT**

NO LOSS PRINCIPLE

COMBINED HEAT AND POWER GENERATION THE MOST EFFICIENT FORM OF ENERGY USE

A STRATEGIC DECISION

CHP refers to the simultaneous generation of electrical and thermal energy from one energy source within a single system. This enables sensational results in terms of energy efficiency and offers the advantage of producing both forms of energy in a continuous, reliable and safe manner.

Energy costs can thus be significantly reduced whilst simultaneously lowering CO₂ emissions. This means, CHP has promising potential to support a financeable energy transition and a sustainable energy supply in order to achieve the ambitious climate goals.

Especially where a particularly secure power supply is needed, CHP systems integrated into building technology can no longer be ignored: whether it is only a matter of simple room heating or process heat generation, modern CHP solutions always ensure a reliable and off-grid power supply.

Cold chain protection in retail and logistics, operating theatre power protection, securing the power supply in buildings with high people frequency and/or high safety requirements, securing sensitive production processes - these are just some of the additional arguments for the use of a CHP.

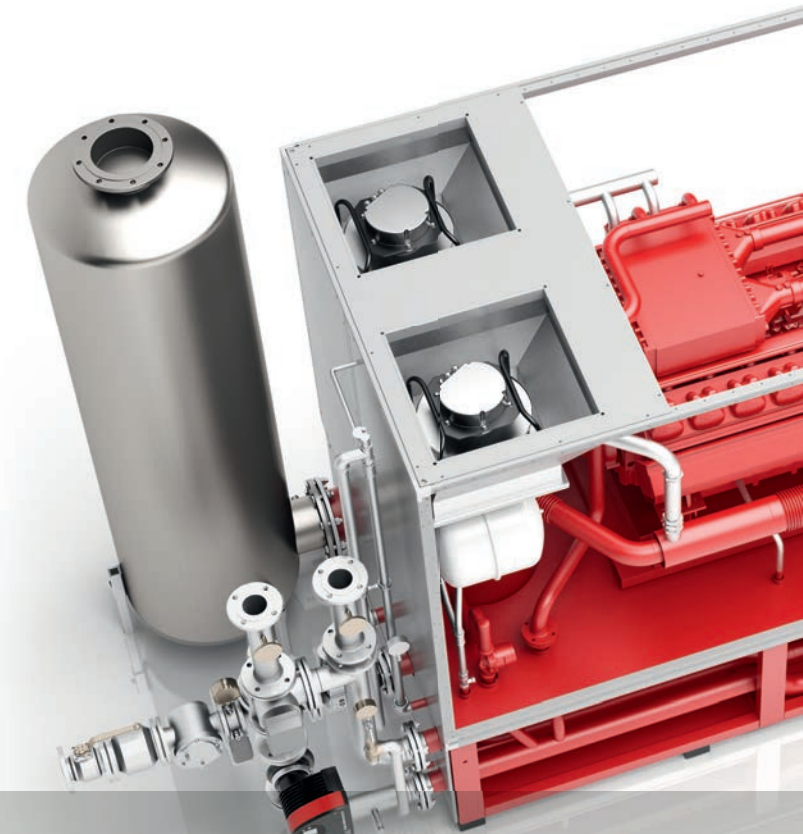

COMBINED HEAT AND POWER GENERATION

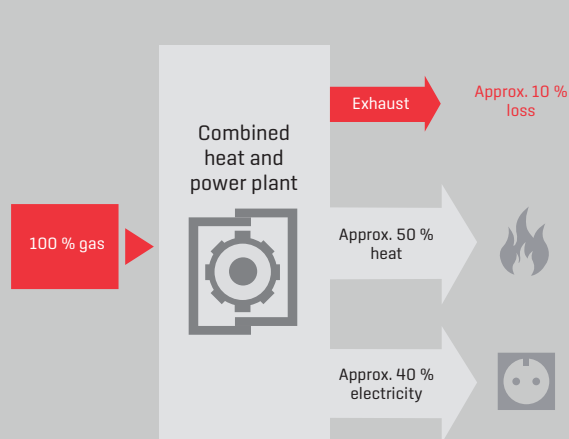

BENEFITS OF COMBINED HEAT AND POWER GENERATION

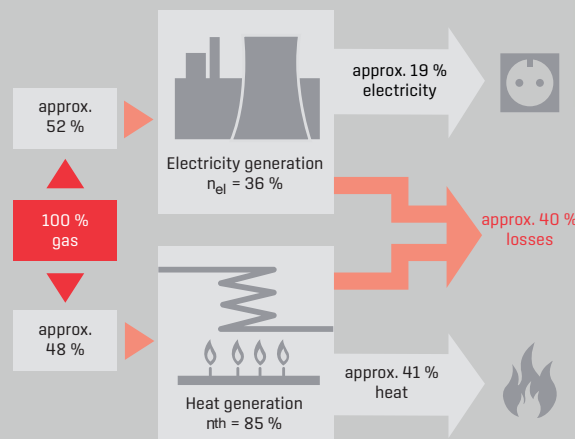

By building many small combined gas-fired power plants, massive grid expansion can be avoided. These CHPs can be combined and controlled as virtual power plants.

Anyone who decides today for a solution from WOLF Power Systems can certainly continue to expand their system the day after tomorrow and expect productivity gains and, at the same time, protect the environment.

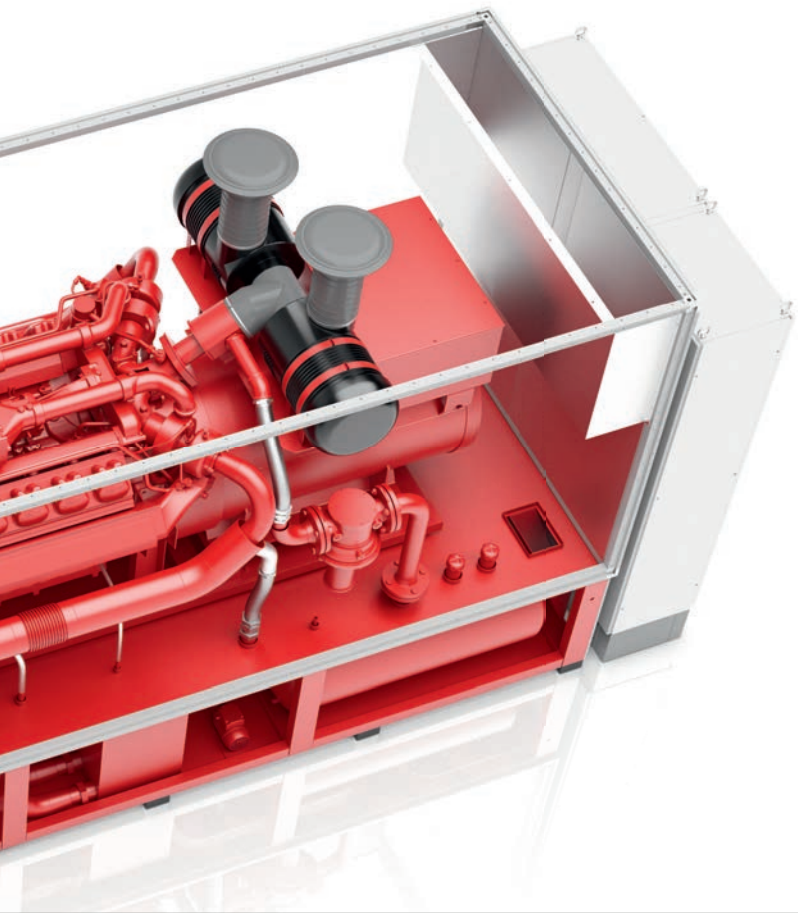

CLIMATE POLICY AND THE RENEWABLE ENERGY ACT (EEG)

Germany is already regarded as an international role model for environmentally friendly energy supply and is a leading technology location. As a manufacturer, WOLF Power Systems also contributes to this with practical solutions for decentralised energy supply and combinations of CHP and renewable energies.

However, in order to continue the success story of the phase-out of coal and nuclear energy, it is necessary to subsidise suppliers of self-generated and -consumed energy with the EEG Act. For example, entrepreneurs could organize themselves in energy cooperatives for independent energy supplies. It is only through decentralisation that the energy and mobility revolution can be successfully implemented.

CHP: EFFICIENT AND CLIMATE-FRIENDLY

- High efficiency > 90 % from on-site electricity and heat use
- Decentralised energy supply
- Substantial reduction in energy costs
- Valuable contribution to environmental protection: reducing CO₂ emissions [approx. 60 %]
- Welcomed by environmental groups and state-sponsored [EEG]
- Reliable energy supply: independent of wind and sun

COMBINED HEAT, COOLING AND POWER GENERATION IN DETAIL

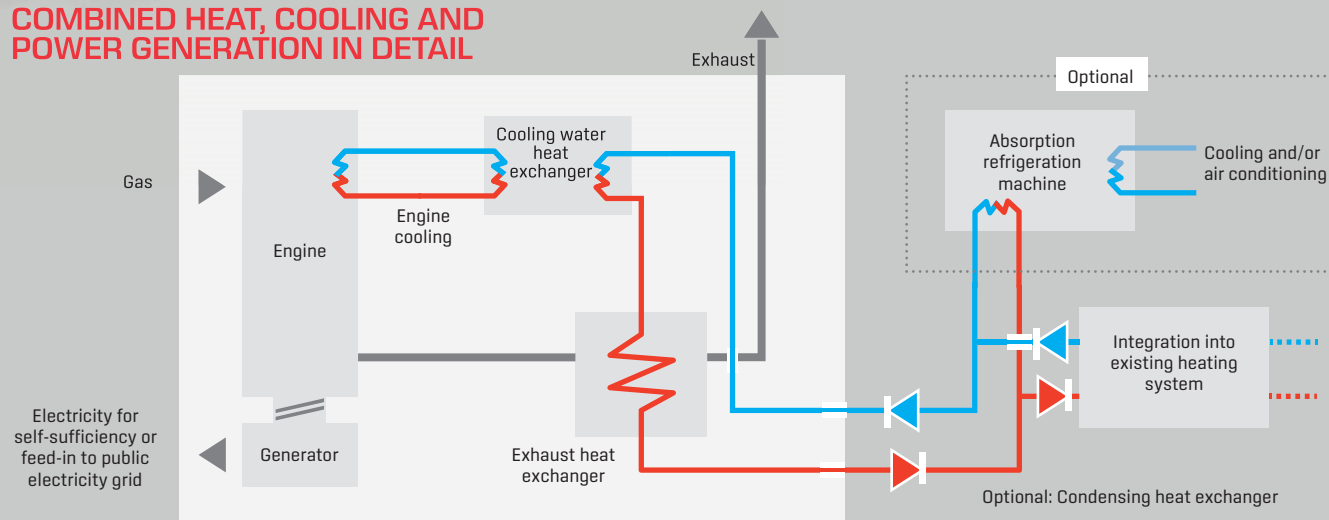

BLUECOMPETENCE
Alliance Member

Partner der Nachhaltigkeitsinitiative
des Maschinen- und Anlagenbaus

Kuntschar + Schlüter is one of the first member companies of the "BLUECOMPETENCE Alliance". In 2011, another BlueCompetence campaign was launched within the framework of the VDMA [Association of German Machine and Plant Manufacturers] interest group. To date, 37 organisations and 345 companies have joined the initiative.



[POWER SYSTEMS]

»» The motor of the future is electric. E-mobility is NOW.
With the NEWTRON system, we offer a way to generate,
store and provide energy for electric cars.



**ENERGY FOR CHARGING
STATIONS AND HEATING**





Maybank

WE PRESENT:
NEWTRON

EXTREMELY DIVERSE

CLIMATE-FRIENDLY ENERGY SUPPLY FOR BUILDINGS AND CHARGING INFRASTRUCTURE

THE NETWORK PROBLEM

The mobility revolution is picking up speed and presenting many companies with the question: How can we let our customers and employees charge their electric vehicles on-site? However, the local power grid is often not designed for additional charging loads and, therefore, must be upgraded in a time-consuming and costly manner. And even if the power grid is designed for high performance, the peak loads that occur when charging electric vehicles cause high costs.

DECENTRALISED CHARGING CURRENT

The NEWTRON system generates electricity on site for charging stations and heat for the adjacent buildings. For this purpose, it combines the energy from the photovoltaic system and the combined heat and power plant with a battery and a heat storage system. The special feature: The NEWTRON produces electricity and heat using CHP with an overall efficiency of approx. 90 %. This reduces energy costs and CO₂ emissions.

COMPONENTS NEWTRON

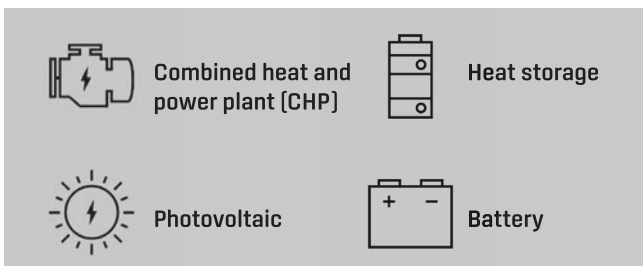

CLEVERLY CONNECTED

The heart of the project: The NEWTRON energy management system integrates existing systems (e.g. heating, photovoltaic) and allows all generators and consumers of electricity and heat to combine intelligently. In this way, locally generated energy is optimally utilised and at the same time expensive load peaks are avoided.

ENERGY FROM THE CONTAINER

In-house installation is not always possible or desired: The NEWTRON provides the components in a mobile container as a complete solution, thus enabling the rapid construction of charging infrastructure and at the same time remaining completely flexible if the requirements should change.

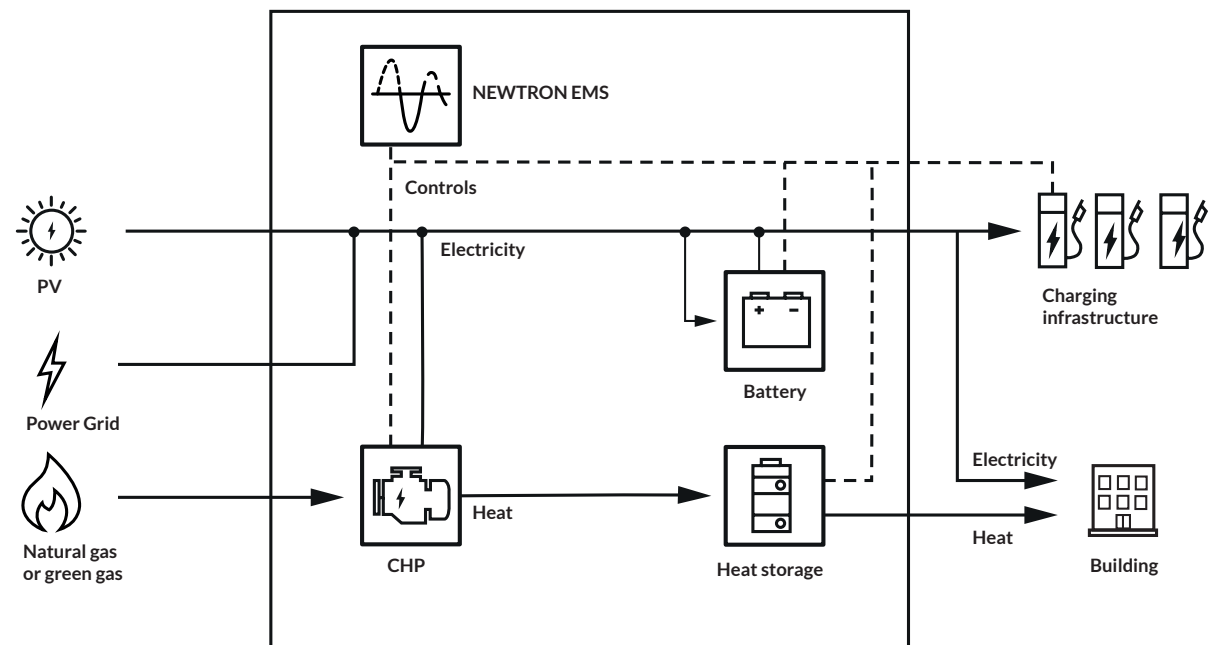

BENEFITS OVERVIEW

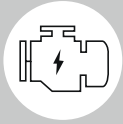

INDEPENDENT & DECENTRAL

Due to decentralised power generation and storage capability directly at the place of consumption, there is no dependence on the maximum performance of the local electricity grid.



HIGH-VOLTAGE COMPATIBILITY STRAIGHT FROM THE FACTORY

The NEWTRON system is compatible with DC and AC-current charging technology in the high-voltage range.



VERSATILE & MODULAR

The modular NEWTRON system can be used in many different ways. The system components can be dimensioned in such a way that they are optimally matched to the existing infrastructure and usage behaviour.



FAST & FLEXIBLE BY PLUG & PLAY

The placement of all components in standard mobile containers enables a fast, space-saving assembly and installation on-site. If the demand changes, the NEWTRON can be easily installed at a different location.



GRID AND COSTS STABILITY BY PEAK-SHAVING

With 100 % grid supply, expensive load peaks occur. This can be avoided by buffering the load through the high-performance batteries, used as intermediate storage, and by using self-generated electricity from the CHP and photovoltaic systems.



HIGHLY EFFICIENT DUE TO COMBINED HEAT AND POWER GENERATION

The CHPs used in THE NEWTRON generate the charging current economically and ecologically extremely favourably with efficiencies of up to 90 %. The waste heat is used for the air conditioning (heating and cooling) of surrounding buildings at the location of energy production.

AVAILABLE IN 3 MODELS

NEWTRON 20 kW

Electrical output: 20 kW
Thermal output: approx. 46 kW
Buffer storage capacity: 2,000-4,000 l
High performance battery:
Output: 30 kW, Capacity: 30 kWh
Charging station management: 2 x 22 kW

NEWTRON 50 kW

Electrical output: 50 kW
Thermal output: 79-84 kW
Buffer storage capacity: > 4,000 l
High performance battery: (optional 2 x)
Output: 50 kW, Capacity: 60 kWh
Charging station management: 4 x 22 kW

NEWTRON 100 kW

Electrical output: 100 kW
Thermal output: approx. 136 kW
Buffer storage capacity: > 6,000 l
2 x High performance battery: (optional 3 x)
Output: 50 kW, Capacity: 60 kWh
Charging station management: 8 x 22 kW

IDEAL FOR:



Car showrooms



Hotels



Craftsmen



Logistics companies



Mobile care services



Public services

OUR SERVICE

Based on the result of your consumption data evaluation, we calculate your personal costs and CO₂ savings potential.

Then we configure your NEWTRON system and plan the optimal location and installation, whilst at the same time supporting you in the use of grants and financing options.

Even after installation, we support your project with ongoing service.





[POWER SYSTEMS]

THE ROAD TO CHP - WE ACCOMPANY YOU

WE SUPPORT
YOU IN

6
STEPS

TO YOUR CHP





The purchase of a CHP is a worthwhile investment that pays off quickly. Together with you, we develop the ideal solution and provide you with competent support throughout the entire process. Let's get started!



FROM INITIAL OFFER TO LIFETIME SERVICE

WPS AS PARTNER WHAT YOU CAN RELY ON

QUALITY AND RELIABILITY AT THE HIGHEST LEVEL

Your satisfaction is most important to us. For this reason, all production sites at WOLF Power Systems are certified in accordance with **DIN EN ISO 9001**, i.e. you can rely on particularly high product and process quality - from sales to production right up to our service.

HIGHEST SYSTEM AVAILABILITY

An efficient CHP is the result of reliable and optimally coordinated technologies. That is why we only use system components that have proven themselves in use, develop some of the technologies ourselves and optimize their interaction. We ensure that your system works perfectly and, thus, achieve a plant availability of up to 99 %.

COMPACT DESIGN AND OPEN ARCHITECTURE

BHKWs CHPs from WOLF Power Systems are characterised by a compact design that has been successfully used for years. All important components in the power range up to 550 kW, are parts of the compact module and reduce the space requirement in your system. At the same time, we ensure easy accessibility of all components for adjustment, monitoring and service. For special applications, e.g. for biogas plants, our open design is also available for plants > 200 kW. Maintenance time and the associated costs are reduced. A standardised soundproofing cabin also reduces vibration noise and the necessity of cost-intensive building sound insulation devices.



FROM THE INQUIRY TO THE FINAL PRODUCT

A system must be specially adapted to the customer's needs and local conditions. This is the only way to make full use of the technical potential of the individual CHP components. The requirements are individual, but there are always certain parallels in the process. Basically, the process of creating a plant can be divided into 6 steps, which it takes through to its realisation.

6 STEPS TO SUCCESS

STEP BY STEP TO YOUR OWN CHP PLANT

- 1 PREPARING THE OFFER**
Feasibility study or profitability calculation based on individual circumstances
- 2 CUSTOMER-SPECIFIC SOLUTION**
Electrical engineering, mechanical engineering, process engineering, support during project approval
- 3 PRODUCTION**
Construction and assembly at our own production site in Wolfhagen
- 4 INSTALLATION**
As a certified contract installation company for gas and electrics, we take care of the hydraulic, mechanical and electrical connections to existing systems, and ensure rapid installation and commissioning on site
- 5 PLANT VISUALISATION & MONITORING**
Selection of operating settings, monitoring of operating conditions and plant performance, notification of possible irregularities
- 6 SERVICE**
Always available: telephone support, control and programming service with diagnostics and assistance by remote dial-in, service fleet in use throughout the country for personal support on-site, engine and spare parts service, emergency service outside business hours, ...

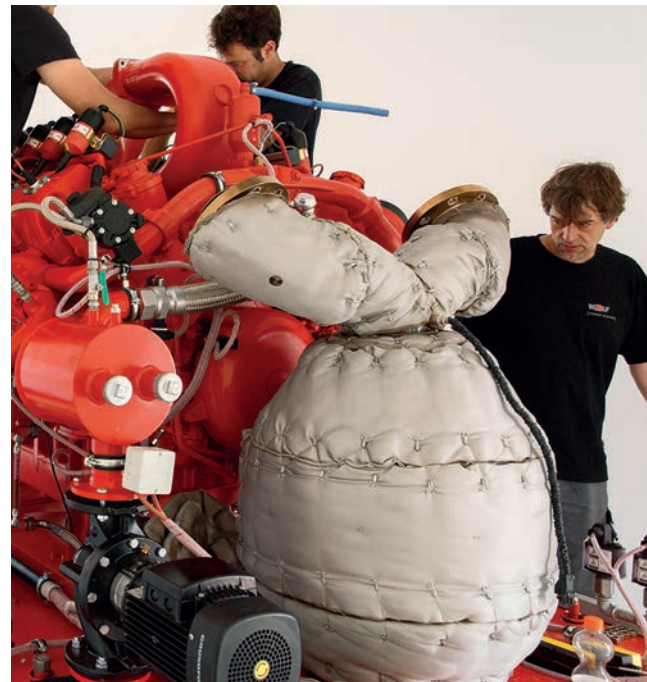

The logo for Wolf Power Systems, featuring the word "WOLF" in a bold, white, sans-serif font with a red circle over the letter "O".

WOLF

[POWER SYSTEMS]

OUR TEAM
IS THERE FOR YOU

365 DAYS

A YEAR

**SERVICE CONCEPT FOR HIGH
PLANT AVAILABILITY**



Your CHP will accompany you for many years. Professional maintenance, carefully tailored to your system, contributes significantly to the service life and flawless function. Major disturbances can be prevented as far as possible by consistent testing and timely precautions.

In the event of unforeseen events, we offer solutions as quickly as possible to minimize unnecessary downtime and associated financial consequences.





SUPPORT GUARANTEED

SERVICE THAT KEEPS WHAT IT PROMISES

PERSONAL ACCESSIBILITY AROUND THE CLOCK

In order to minimize waiting times and, in an emergency, downtimes in the event of faults in your system, you can reach us through many channels, all year round, every day. You always have a contact person at your disposal, your request will be taken up and dealt with immediately.

EFFECTIVE MAINTENANCE

With individual maintenance and service based on the status of the system, which are precisely tailored to your circumstances, we can prevent unscheduled downtimes and costly repairs. Here we go beyond the recommendations of the engine suppliers and utilise the many years of experience we have gained from the multitude of our projects.

MAINTENANCE CONTRACTS: FULL COST TRANSPARENCY AND FAIRNESS

Regular maintenance and care of all system components is a prerequisite for the long-term reliable and economical operation of your CHPs. With the contractually stipulated, regular maintenance, you have virtually nothing to worry about. We keep an eye on all service intervals and inform you about upcoming appointments.

**HELPDESK
FAULT SERVICE
MAINTENANCE
SERVICE**

OUR SPARE PARTS SERVICE - ALSO AVAILABLE ONLINE

EXTENSIVE ASSORTMENT IN STOCK FAST, NATIONWIDE SUPPLY

ORIGINAL ACCESSORIES AT ANY TIME

The system and the spare parts must be compatible to maintain high quality, operational reliability and efficiency of the entire system. This is guaranteed with original spare parts, accessories and operating materials from renowned manufacturers.

In order to minimize downtime when replacing these elements, we have a wide range of common supplies tested and proven for you at our well-stocked spare parts warehouses.

With the help of well-developed logistics in combination with our flexible, mobile service fleet, the installation can take place professionally and quickly, and your plant operation can continue almost without interruption.

The WOLF Power Systems main warehouses are located in Wolfhagen and Gorleben at the two main service points.

But because we also do not want to wait for deliveries for you, other decentralised warehouses are located nationwide.

Thanks to state-of-the-art logistics and networking, we are able to act quickly and intervene where necessary.



WPS ONLINE SHOP - REGISTER NOW!

Simply get an overview of accessories and product ranges or order items, wherever you are: very easy with our online shop.

Take advantage of our attractive discount promotions!

www.wolf-ps-shop.de

Also available
for download
as an APP!



REVISION AND ENGINE SERVICE

INTELLIGENT MAINTENANCE SYSTEM INCREASES RUNTIME

MAINTENANCE AFTER DIAGNOSIS

As in medicine, we regularly subject your machine to a "health check" using state-of-the-art diagnostic technology. If something does not seem to be running quite smoothly, we first research the root causes before starting therapy measures.

We always act in your interest, inform you about the status of the results and offer solution options. Only after consultation with you will components be replaced where necessary. The repairs are carried out at our factory.

REVISION/ENGINE SERVICE

We create an individual maintenance plan for each plant. At each upcoming service interval, the scope of the required maintenance steps will be coordinated and executed with you after prior inspection. Carefully planned protection has a lasting effect on the function of your CHP.

REPLACEMENT ENGINE: REDUCE DOWNTIME

In order to keep the performance of your system at a consistently high level, a suitable engine upgrade or the change to a completely overhauled, tested model from the latest series can be effective. Profit from benefits such as lower gas consumption, lower fuel costs and a higher yield. You will of course receive a warranty on all replaced components.

OUR OWN
ENGINE REVISION
AT THE
GORLEBEN SITE!



CONTROL & PROGRAMMING SERVICE

Today, combined heat and power generation largely thrives on software solutions. Modern CHPs are complex systems with far more than just mechanical aspects. Nowadays, many optimisations and upgrades can also be carried out by appropriate programming. This increases efficiency and ease of use, so we can specifically adapt to your needs.

OPERATING COMFORT FOR OWNERS

Conveniently control the system start-up via smartphone, keep an eye on the latest status messages in real time and monitor the operation process, no matter where you are? Many useful applications and upgrades that make plant operations easier are included in our maintenance offers. Let us talk about your individual optimisation framework.

IDENTIFY WEAKNESSES BEFORE THEY ARISE

Our qualified service personnel are also trained for interventions in plant control. In addition, all engine data and operating parameters are automatically recorded by the system. This provides a valuable data base for potential analysis for plant optimisation and early detection of emerging power drops, providing additional protection against downtime.

EXTRA SERVICES

Emission measurements, cleaning of the exhaust heat exchanger, calibration of the gas warning system, optimised oil management, ...
Please contact us!

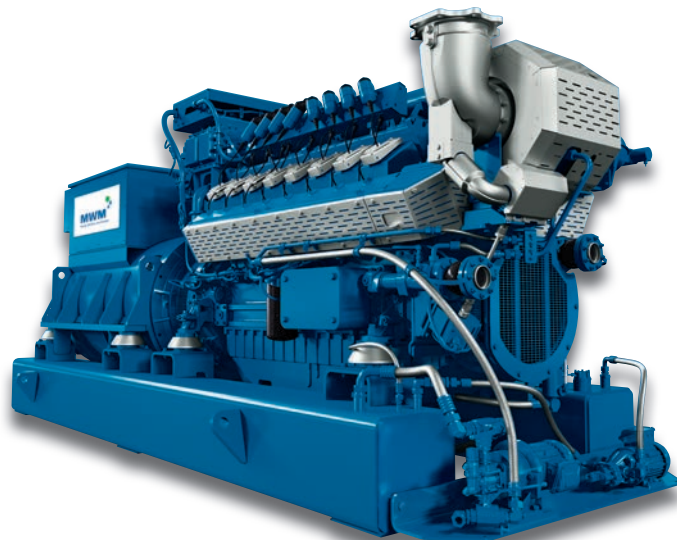

Picture MWM:
© Caterpillar Energy Solutions GmbH,
Mannheim



FREE AND INDEPENDENT

You do not own one of our plants? No problem! The know-how of our employees goes far beyond our own products. We are very familiar with the systems of other manufacturers and provide unrestricted expert service here as well.

With our range of individual maintenance contracts, you can keep your head free and focus on your own business.

CROSS SECTOR INTEREST

Whether independent farms or public institutions: a maintenance contract with defined framework conditions provides you with clarity on the scope of all services and a safe, relaxed feeling.



**LONG-TERM SATISFIED
CUSTOMERS**



As a pioneer of combined heat and power generation, we have been developing CHP solutions of all sizes and for all areas of decentralised energy supply for more than 35 years. Our portfolio of satisfied customers endorses our work and at the same time encourages us to continue to play a leading role as technology experts with excellent back up service.

We are looking forward to exciting new projects, maybe with you?



EXTRACT FROM OUR PROJECT PORTFOLIO

- Humboldt University, Berlin • GTK 140
- Trade fare Hannover, Hannover • GTK 70 BW
- District Office, Bayreuth • GTK 110
- Goethe-Institute, München • GTK 70
- Hotel Fürstenhof, Bad Griesbach • GTK 140
- Nordfriesland Klinik, St. Peter-Ording • GTK 140
- Maritim Hotel, Bremen • GTK 140
- Riot Police, Nürnberg • GTK 140
- Telekom Service Center, Dortmund • GTK 18
- Kaiser indoor swimming pool, Bad Abbach • GTK 240
- Meridian Spa, Frankfurt am Main • GTK 50
- Austro Energy Systems, Moscow, Russia • GTK 70
- Thüringen Clinics, Saalfeld • GTK 140
- E.ON Bayern, Roththalmünster • GTK 200 M
- Hamburg water utility GmbH, Hamburg • GTK 240
- Evonik, Essen • GTK 50 BW
- Schlosshotel Lerbach, Bergisch Gladbach • GTK 35 M
- Schön Clinic, Vogtareuth • GTK 140
- Prison, Weiden in der Oberpfalz • GTK 50 BW
- Wastewater treatment plant, Lutherstadt Wittenberg • GTK 180 K
- Police station, Schweinfurth • GTK 50 BW
- REWE, Hildesheim • GTK 225 M
- Police Academy, Lübeck • GTK 70
- Munciple works, Lübeck • GTK 50
- Sanatorium, Sochi, Russia • GTK 210
- Zoo, Heidelberg • GTK 50 M
- Kaiserhof, Bad Gastein, Österreich • HTK 230
- Munciple works, Münster • GTK 30
- Indoor swimming pool, Husum • GTK 185
- Wastewater treatment plant, Rm Valcea, Romania • 2 x GTK 120 K
- Centro Sportivo Falco, Italy • GTK 140
- Cable factory, Proletarsk, Russia • GTK 400 M
- Car Showroom, St. Petersburg
- Arborea Marina Resort, Neustadt [in Holst.]
- Playmobil, Geobra Brandstätter, Herrieden
- Siemens plant, Rastatt
- Hengstenberg, Fritzlar
- Futurium, Berlin
- Maritim Hotel, Flughafen Düsseldorf
- Student housing complex, Uni Düsseldorf
- Pure Power, Heidesee
- va-q-tec, Würzburg
- Kalchreuther Bäckerei, Eckental-Eschenau



Above: Schlosshotel Lerbach
 Left: Rüppe plant
 Right: Student housing complex
 University of Düsseldorf



Top left: Rainbow Park Wuppertal
Top right: Volvo centre St. Petersburg
Bottom left: Maritim Hotel Düsseldorf
Bottom right: Butcher's shop Brandenburg



© Concept & Design: Schwarzbuch-Grafikdesign, Gartow

WOLF
[POWER SYSTEMS]

WOLF POWER SYSTEMS GMBH

WOLFHAGEN

Unterm Dorfe 8
D-34466 Wolfhagen
Tel.: +49 (0) 5692 9880-0
info@wolf-ps.de
www.wolf-power-systems.de

BRANCH GORLEBEN

Streßelfeld 1
D-29475 Gorleben
Tel.: +49 (0) 5882 9872-0
info@wolf-ps.de
www.wolf-power-systems.de